

Programma SIMPLE

TECHNICAL FEATURES

Wall hung, modular base/tall units with TIP-ON push-opening mechanism. Units with handle are not feasible.

Top (1)

The square-edged top can be fitted with top-mounted, built-in, under-mounted or moulded flush-mounted washbasins.

THICKNESS: 12 - 15 - 20 - 23 mm.

DEPTH: 500 mm

Unit (2)

It's made of 19 mm thick wood particle board panels, waterproof, with low formaldehyde emission (class E1, CARB P2 / TSCA Title VI certified), treated with high performance melamine resin. Front and back edges in ABS, same colour

SIDE PANEL HEIGHT: 300 - 470 mm (both compatible with built-in / under-mounted / moulded flush-mounted Boffi washbasins).

SIDE PANEL DEPTH: 470 mm.

DEPTH INCLUDING DOOR: 495 mm.

MODULE WIDTH: 300 - 450 - 600 - 900 - 1200 mm.



End panel (3a)

In finish, 23 mm thick.

Side panel in finish (3b)

Exterior end panels IN FINISH, AT AN EXTRA CHARGE (please note that front panels in Corian® have finished side panel in white Ecolak and front panels in 3D Wood have finished side panel in wood veneer, without slats effect).

The side panel in finish includes the finishing of the frontal vertical edge too.

Feasible in Easylak+ / Silcolak / Ecolak / Polyester / Easy Metals / Metals / Wood / Clay / Wood Selection / Wood Exclusive.

The side panel in finish IS NOT FEASIBLE in SOLID WOOD (also in 3D / FREEHAND / SHADES versions). For these finishes please order the end panels separately.

Drawers (4)

LEGRABOX series with sides and back in varnished matt black metal. Bottom in black melamine. Front of internal drawers in melamine, same finish as carcass.

Doors and fronts (5)

In finish, thickness 23 mm, with TIP-ON push-opening mechanism.

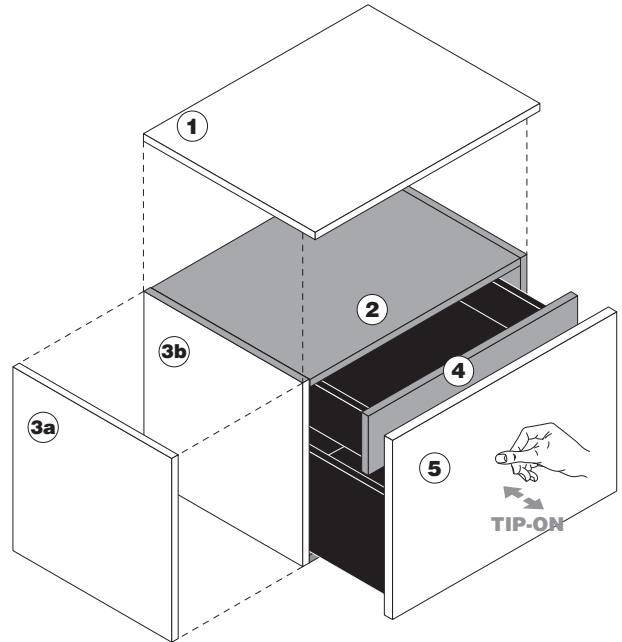

Programma SIMPLE

FEASIBLE FINISHES - CABINETS

MELAMINE-COATED CARCASS

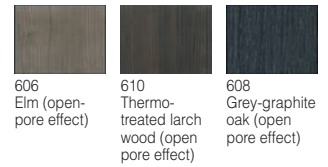

FRONTS FINISH

COLOURS / SPECIES

EASYLAK+

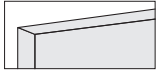

506 Cortina white
507 Leeds grey

LASERMAT



183 Kos white
178 Malè white
179 Luxor beige
187 Arizona beige
184 Efeso grey
202 Antrim grey
181 Londra grey
185 Bromo grey
186 Orinoco cocoa
182 Ingo black



188 Comodoro green
189 Jaipur red
203 Fes blue

SILCOLAK

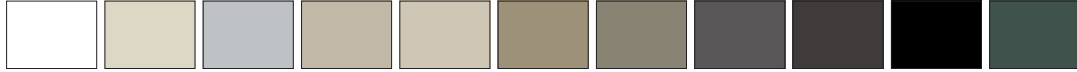

521 Siberia white
523 Oyster-pearl
524 Luton grey
525 Gravel grey
526 Hay
527 Rope-colour
528 Silt
529 Slate grey
530 Abyss black
531 Jet black
532 Myrtus green

ECOLAK



510 Arctic white
129 Magnolia
513 Cloud colour
024 Pebble grey
512 Oat colour
025 Écru
023 Mud
515 Basalt grey
517 Charcoal
027 Black

WOOD

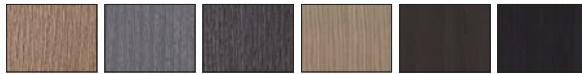
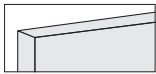

049 Oak
033 Ash-grey oak
076 Grey-graphite oak
334 Ecowood Xilo 2.0 Planked Sand (18.22)
335 Ecowood Xilo 2.0 Planked Grey (18.23)
333 Ecowood Xilo 2.0 Striped Black (18.04)

CLAY

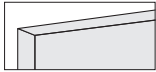

551 Hydra
555 Andromeda
552 Columbia
553 Pegaso
554 Lyra

POLYESTER

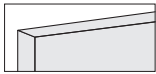

003 White
129 Magnolia
024 Pebble grey
005 Grey RAL 7038
391 Rope-colour
063 Sand
004 Grey
393 Elegant grey
392 Deep grey
027 Black



394 Milky mint
113 Caligo green
117 Jodhpur blue
107 Petra red

WOOD SELECTION

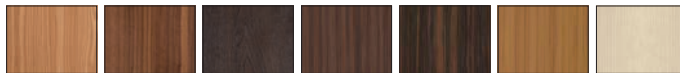

337 American elm
093 Canaletto walnut U.S.
101 Smoked oak
346 Ecowood Indian Rosewood (10.23)
347 Ecowood Datuk Ebony (10.44)
348 Ecowood Teak (10.74)
150 Alpine white oak

EASY METALS

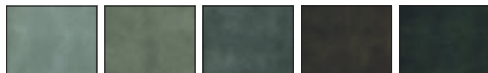
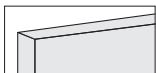

540 Silver style
541 Zinc Glam
542 Iron Luxury
543 Copper Dark
544 Lead Class



606
Elm (open-
pore effect)

610
Thermo-
treated larch
wood (open
pore effect)

608
Grey-graphite
oak (open
pore effect)

FRONTS FINISH

COLOURS / SPECIES

METALS



198 White 934 Aluminium 197 Zinc+ 195 Vintage brass 196 Copper+ 192 Titanium 191 Lead



490 Copper Rayé 492 Brass Rayé 493 Bronzed brass Rayé 495 Antique bronze Rayé 494 Bronze Rayé 491 Lead Rayé

CORIAN®



173
White

WOOD 3D

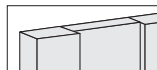

049 Oak 033 Ash-grey oak 076 Grey-graphite oak 337 American elm 334 Ecowood Xilo 2.0 Planked Sand (18.22) 335 Ecowood Xilo 2.0 Planked Grey (18.23) 333 Ecowood Xilo 2.0 Striped Black (18.04) 093 Canaletto walnut U.S. 101 Smoked oak



346 Ecowood Indian Rosewood (10.23) 347 Ecowood Datuk Ebony (10.44) 348 Ecowood Teak (10.74) 150 Alpine white oak

SOLID WOOD



058 LIGHT Canaletto walnut, "sawn" effect 057 "Old" grey pinewood 066 American elm SW 067 Thermo-treated Olivato ash wood SW 102 Smoked dyed oak SW

SOLID WOOD 3D (Price: SOLID WOOD + 10%)

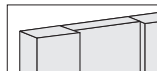

058 LIGHT Canaletto walnut, "sawn" effect 057 "Old" grey pinewood 066 American elm SW 067 Thermo-treated Olivato ash wood SW 102 Smoked dyed oak SW

SOLID WOOD FREEHAND (Price: SOLID WOOD + 15%)



061 LIGHT Canaletto walnut 066 American elm SW 067 Thermo-treated Olivato ash wood SW 102 Smoked dyed oak SW

SOLID WOOD SHADES (Price: SOLID WOOD + 15%)



061 LIGHT Canaletto walnut 066 American elm SW 067 Thermo-treated Olivato ash wood SW 102 Smoked dyed oak SW

WOOD EXCLUSIVE



077
Fossil oak



TOPS FINISH

COLOURS / SPECIES

WASHBASINS

SANDED PAINTED EXTRALIGHT GLASS - H 12 mm

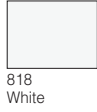
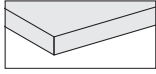

FROSTED PAINTED EXTRALIGHT GLASS - H 12 mm

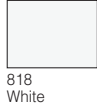
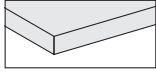

CORIAN® - H 12 mm

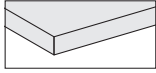

CRISTALPLANT® - H 15 mm

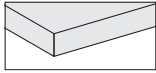

LASERMAT - H 20 mm

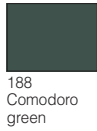
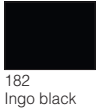
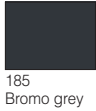
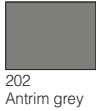
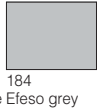
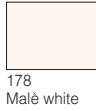
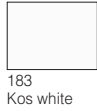
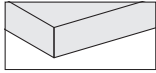

CORIAN® - H 20 mm

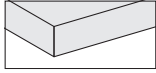

STONE - MARBLE - GRANITE - H 20 mm

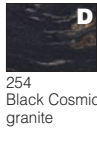
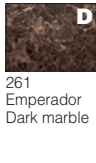
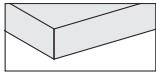

DEKTON® COMPOSITE - H 20 mm

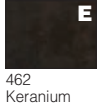
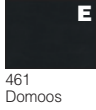
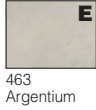
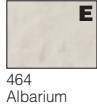
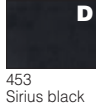
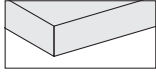



TOPS FINISH

COLOURS / SPECIES

WASHBASINS

MDI COMPOSITE - H 12 mm

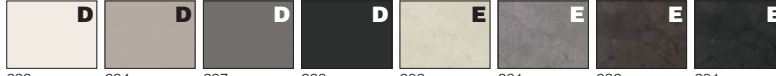
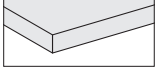

233 White 234 Camel 237 Grey 238 Black 282 Bihara 231 Devon 232 Surrey 281 Kanran



283 Camel cross 284 Camel points 285 Black cross 286 Black points

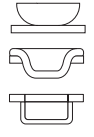

SOLID WOOD - H 23 mm

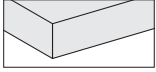

058 LIGHT Canaletto walnut, "sawn" effect 057 "Old" grey pinewood 066 American elm SW 067 Thermo-treated Olivato ash wood SW 102 Smoked dyed oak SW



P r o g r a m m a S I M P L E
TECHNICAL DETAILS - BASE UNIT SIZE CHART

Base unit for washbasin with drawer

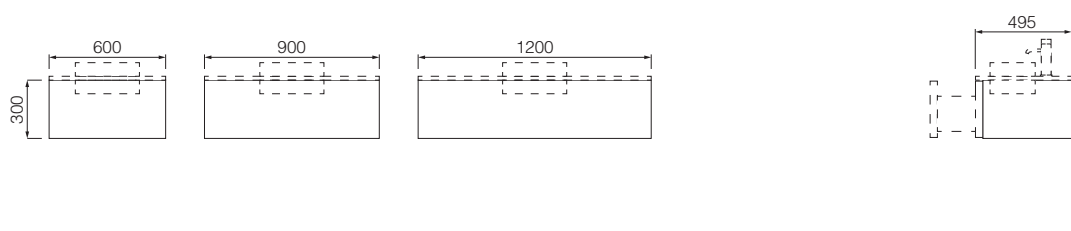

Base unit with drawer

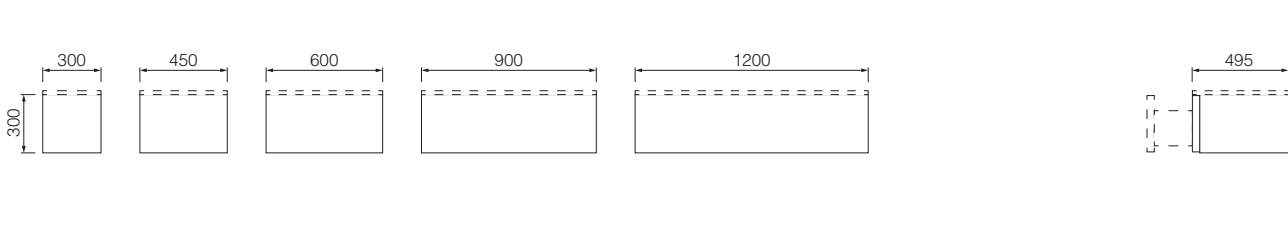

Base unit for washbasin with hinged door/s.

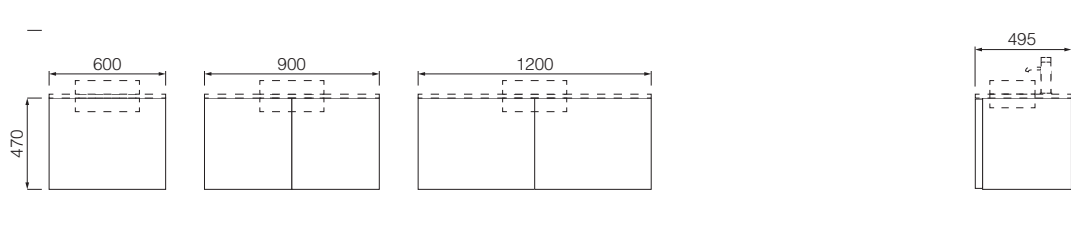

Base unit with hinged door



Base unit for washbasin with 2 drawers

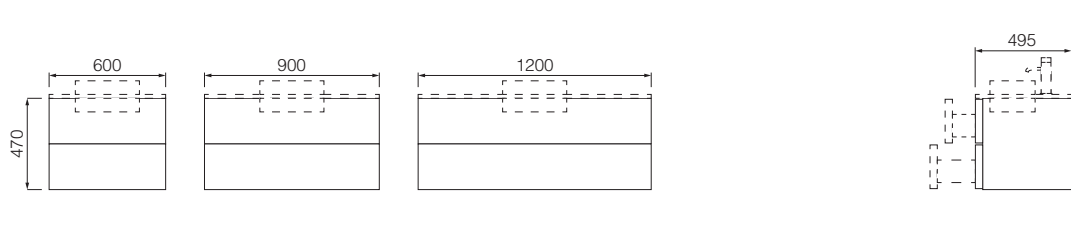

P r o g r a m m a S I M P L E
TECHNICAL DETAILS - BASE UNIT SIZE CHART

Base unit with 2 drawers

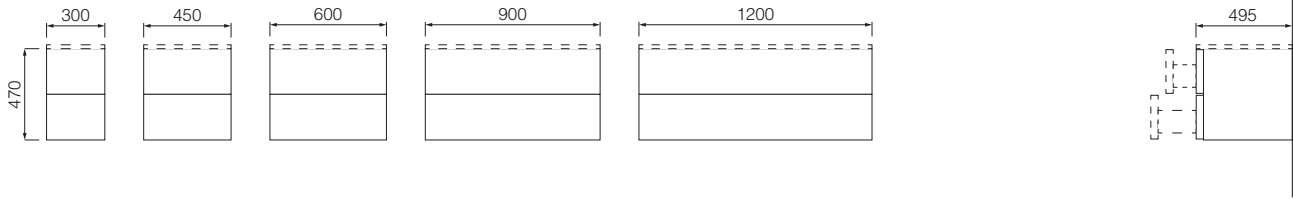

Base unit for washbasin with drawer

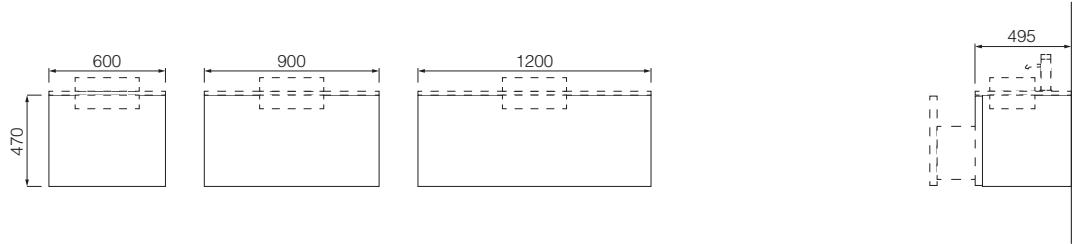

Base unit with drawer + internal drawer

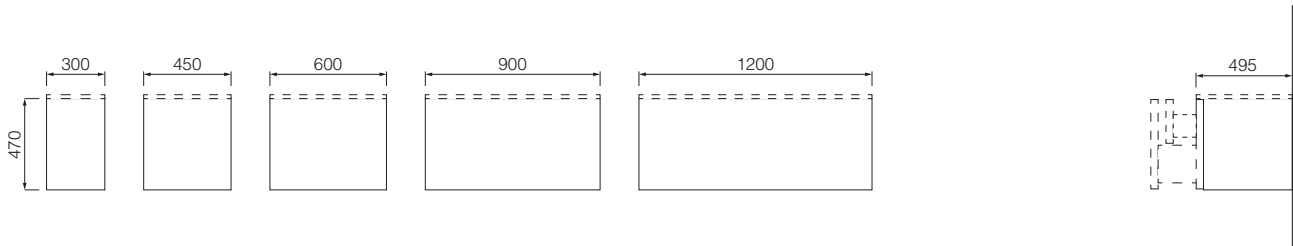

Programma SIMPLE

TECHNICAL DETAILS

INSIDE SPACE OF BASE AND TALL UNITS

Base units for washbasin

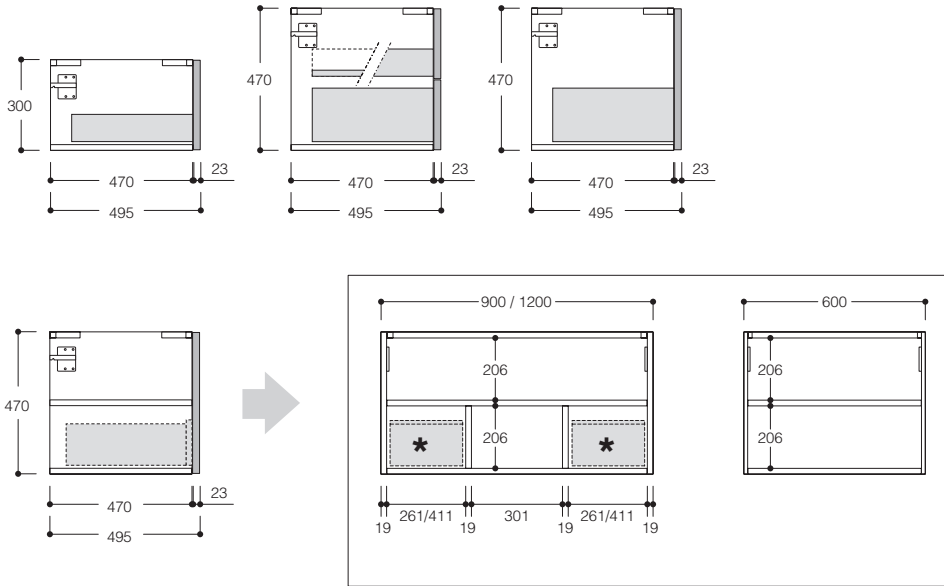

* Optional drawer

Base units and tall units

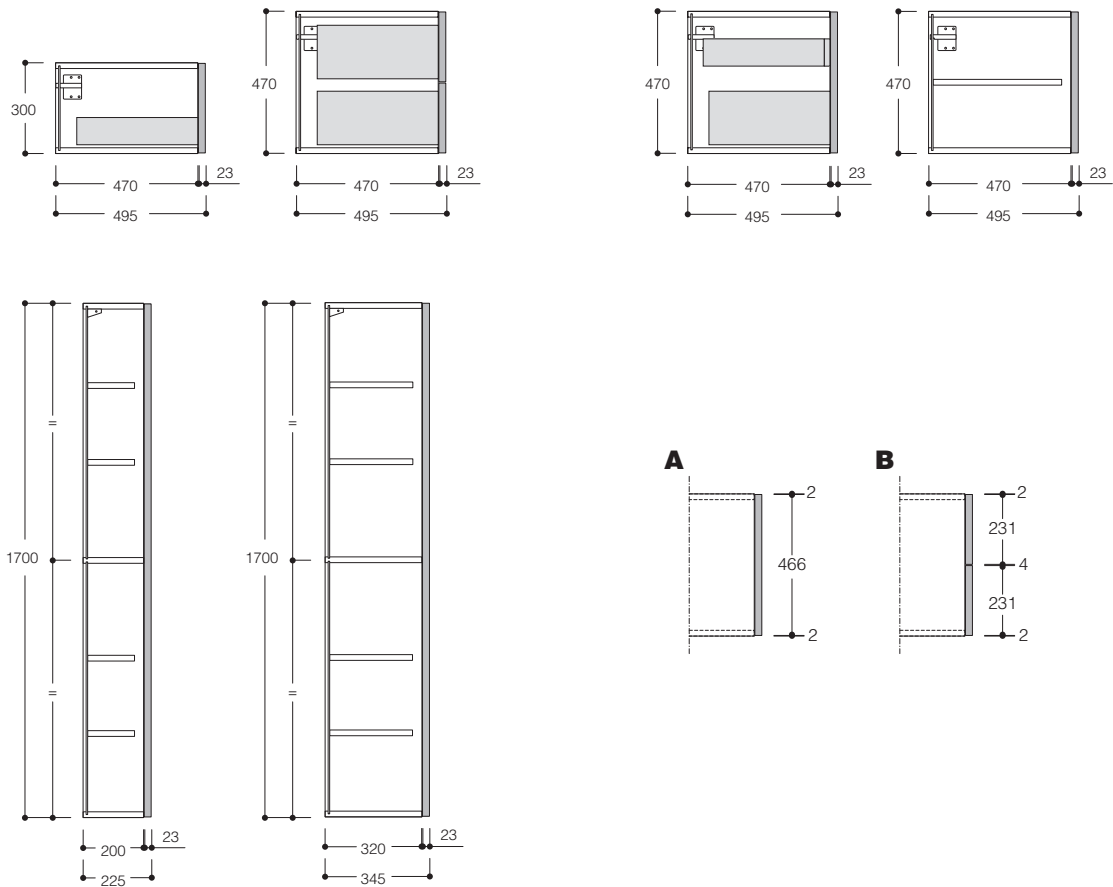

A - Detail of the single front H 470 mm

B - Detail of H 470 mm double front

Programma SIMPLE

TECHNICAL DETAILS - WATER DRAIN POSITIONING

"a" = position of water drain

A = Water drain

B = cold water

C = warm water

BASE UNITS H 300 - TOP-MOUNTED washbasin

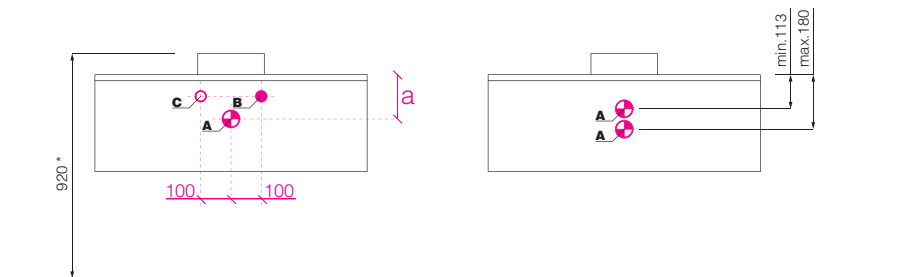
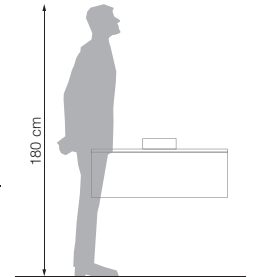
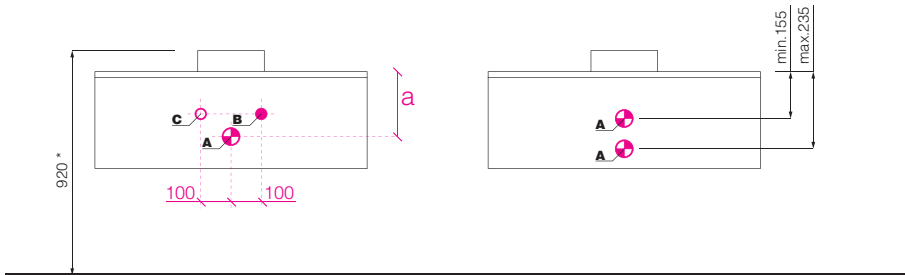
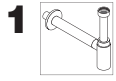

BASE UNITS H 300 mm - UNDER-MOUNTED, moulded FLUSH-MOUNTED and BUILT-IN washbasin.

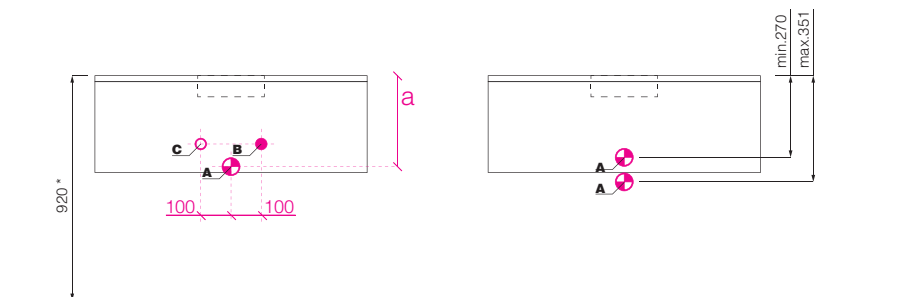
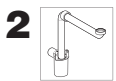
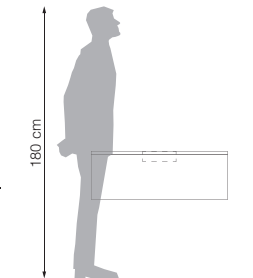
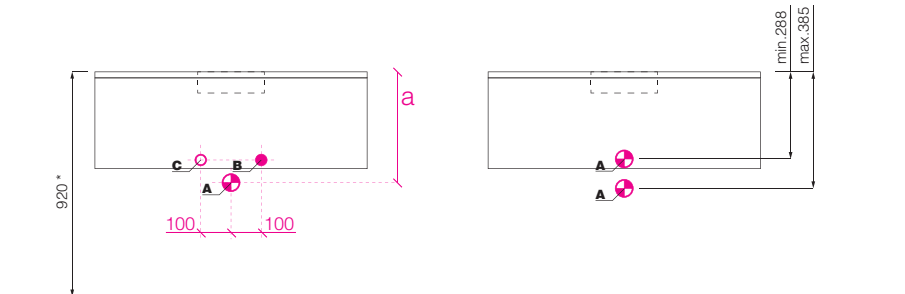
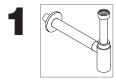

* recommended distance for medium-height users (170 ÷ 180 cm).

1 - Cylindrical syphon

2 - Space-saving syphon

Programma SIMPLE

TECHNICAL DETAILS - WATER DRAIN POSITIONING

"a" = position of water drain

A = Water drain

B = cold water

C = warm water

BASE UNITS H 470 mm - TOP-MOUNTED washbasin

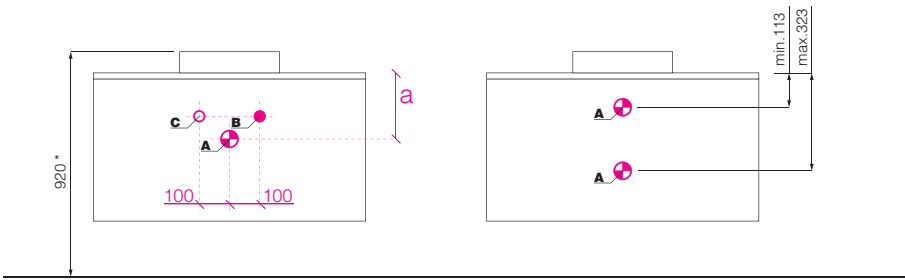
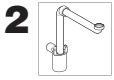
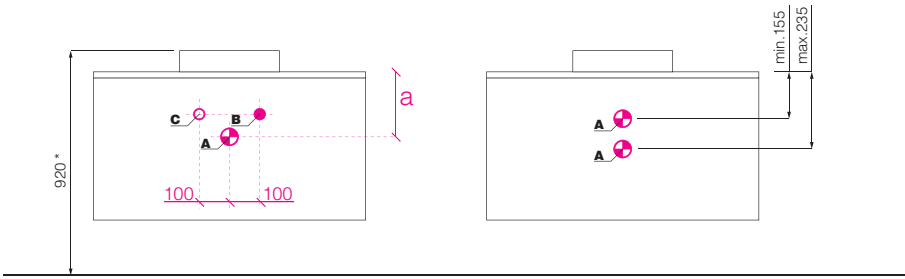
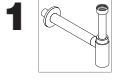

BASE UNITS H 470 mm - UNDER-MOUNTED, moulded FLUSH-MOUNTED and BUILT-IN washbasin.

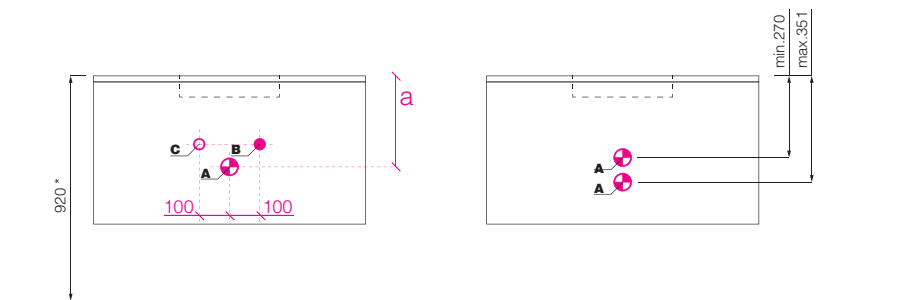
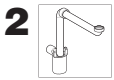
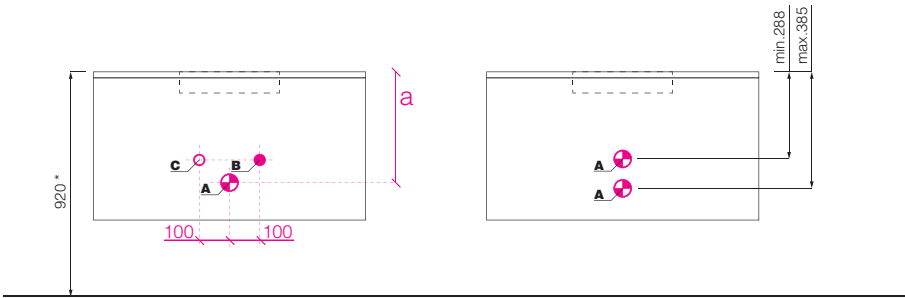
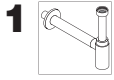

* recommended distance for medium-height users (170 ÷ 180 cm).

- 1 - Cylindrical syphon
- 2 - Space-saving syphon