

# Programma SIMPLE

## CARATTERISTICHE TECNICHE

Sistema modulare di contenitori base / colonna sospesi dotati di sistema di apertura automatica a pressione "tip-on". Non è possibile realizzare contenitori provvisti di maniglia.

### Piano (1)

Piano squadrato allestibile con lavabi sopra piano da appoggio, sopra piano da incasso, sottopiano da incasso o filopiano stampato.  
SPESSORE: 12 - 15 - 20 - 23 mm.  
PROFONDITÀ: 500 mm.

### Contenitore (2)

Realizzato in pannelli di particelle di legno di spessore 19 mm, idrofughi, a basso contenuto di formaldeide (certificato classe E1, CARB P2 / TSCA Title VI) nobilitato con carte ad alta grammatura trattate con resine melamminiche. Bordo anteriore e posteriore in ABS in tinta.  
ALTEZZA FIANCO: 300 - 470 mm (entrambe compatibili con incasso di lavabi Boffi sopra piano da incasso / sottopiano da incasso / filopiano stampato).  
PROFONDITÀ FIANCO: 470 mm.  
PROFONDITÀ CON FRONTALE: 495 mm.  
LARGHEZZA MODULO: 300 - 450 - 600 - 900 - 1200 mm.

### Pannello terminale (3a)

Realizzato in finitura, spessore 23 mm.

### Fianco in finitura (3b)

Fianchi esterni terminali in finitura, CON SOVRAPPREZZO (considerare che per i mobili con frontali in Corian® il fianco finito sarà in Ecolak bianco / per mobili con frontali in Legno 3D il fianco sarà in impiallacciato liscio, senza effetto-listoni).  
Il fianco in finitura comprende anche la finitura del bordo verticale a vista.  
Realizzabile nelle finiture EasyLak+ / Silcolak / Ecolak / Poliestere / Easy Metals / Metals / Legno / Clay / Legno Selection / Legno Exclusive.  
Il fianco in finitura NON è realizzabile in LEGNO MASSELLO (anche nelle versioni 3D / FREEHAND / SHADES). Per queste finiture è necessario ordinare separatamente i pannelli terminali.

### Cassetti (4)

Sistema LEGRABOX, con spondine laterali e posteriore in metallo verniciato in colore nero opaco. Fondo in nobilitato nero. Frontale cassetti interni in nobilitato finitura contenitore.

### Ante e frontali (5)

Realizzate in finitura, spessore 23 mm, con apertura automatica "tip-on".

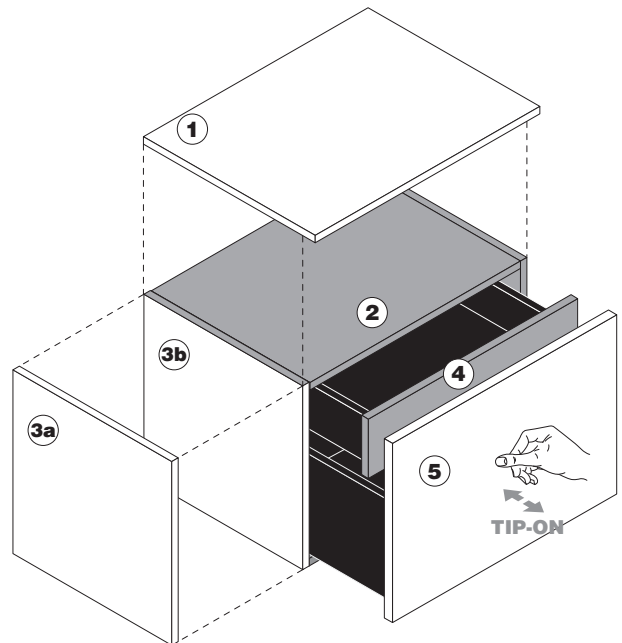

# Programma SIMPLE

FINITURE REALIZZABILI - MOBILI

CONTENITORE  
NOBILITATO

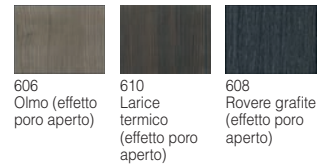

FINITURA  
FRONTALI

COLORI / ESSENZE

EASYLAK+

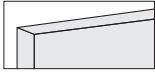

LASERMAT

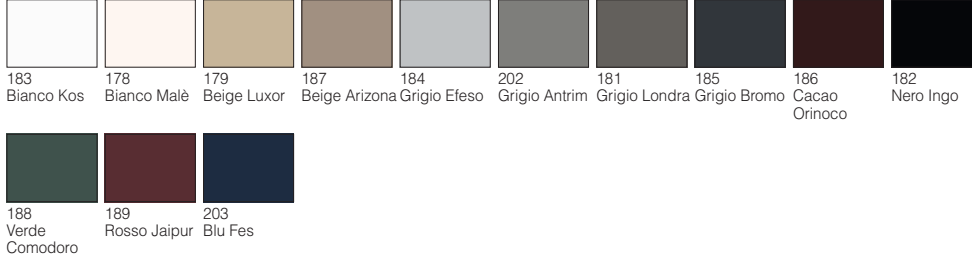
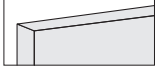

SILCOLAK

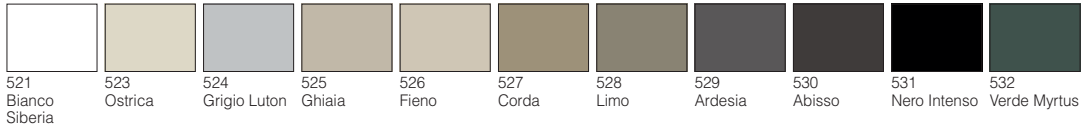

ECOLAK

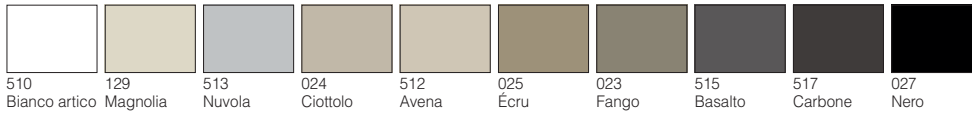

LEGNO

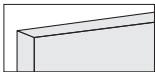

CLAY



POLIESTERE

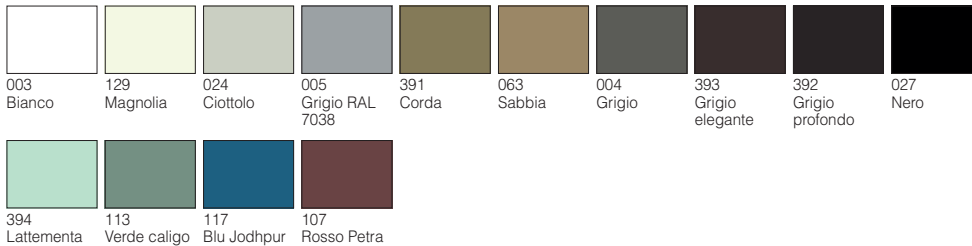

LEGNO SELECTION

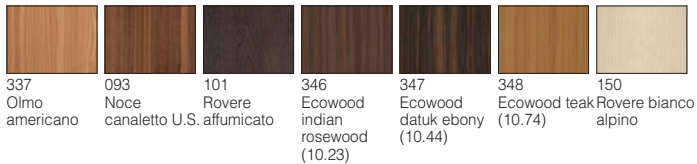

EASY METALS



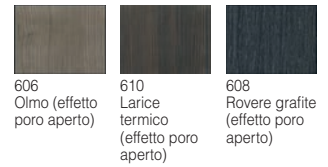

FINITURA  
 FRONTALI

COLORI / ESSENZE

METALS

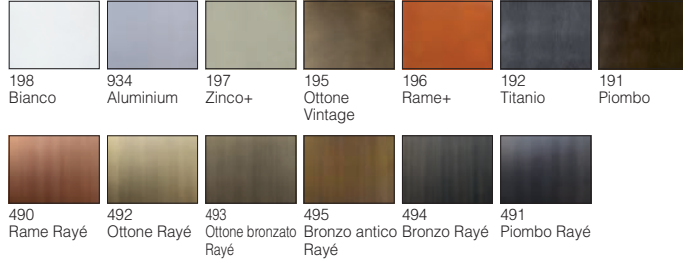
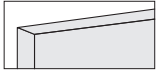

CORIAN®

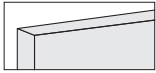

LEGNO 3D

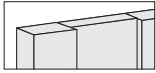

LEGNO MASSELLO

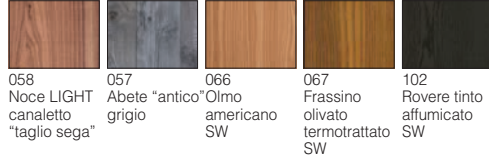

LEGNO MASSELLO 3D (Prezzo: LEGNO MASSELLO + 10%)

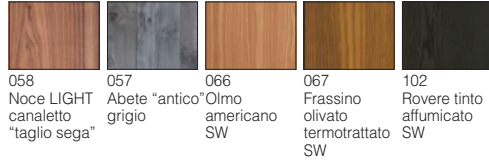
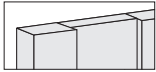

LEGNO MASSELLO FREEHAND (Prezzo: LEGNO MASSELLO + 15%)

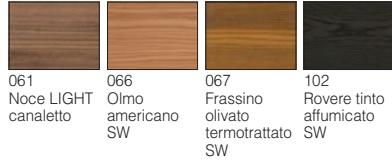
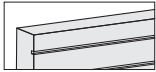

LEGNO MASSELLO SHADES (Prezzo: LEGNO MASSELLO + 15%)

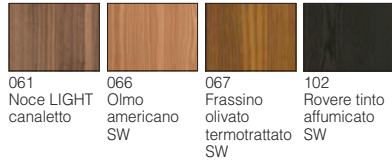
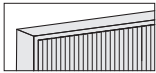

LEGNO EXCLUSIVE

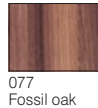
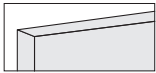



FINITURA PIANI

COLORI / ESSENZE

LAVABI

VETRO EXTRALIGHT SABBIAITO VERNICIATO - H 12 mm

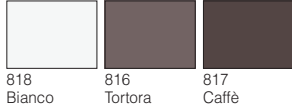
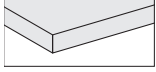

VETRO EXTRALIGHT ACIDATO VERNICIATO - H 12 mm

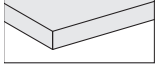

CORIAN® - H 12 mm

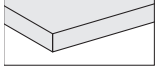

CRISTALPLANT® - H 15 mm

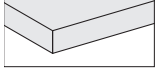

LASERMAT - H 20 mm

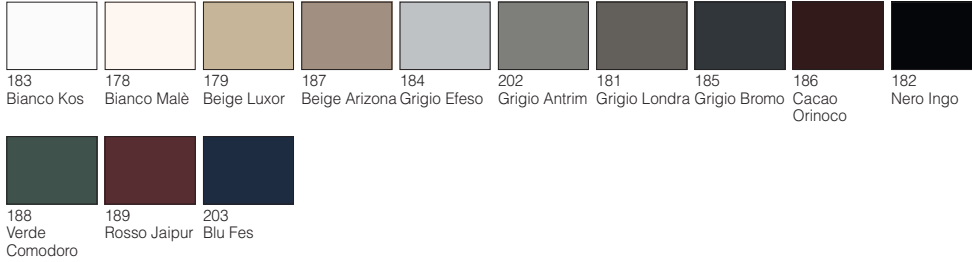
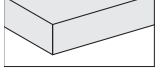

CORIAN® - H 20 mm

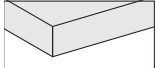

PIETRA - MARMO - GRANITO - H 20 mm

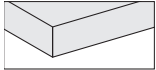

COMPOSITO DEKTON® - H 20 mm

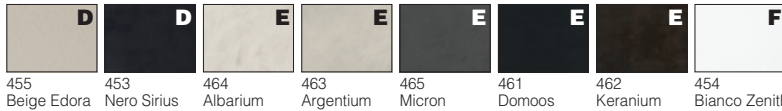
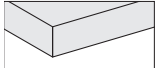



SOPRAPIANO  
da appoggio



SOPRAPIANO  
da incasso



SOTTOPIANO  
da incasso



FILOPIANO  
stampato

FINITURA PIANI

COLORI / ESSENZE

LAVABI

COMPOSITO MDI - H 12 mm

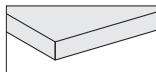

233  
Bianco



234  
Cammello



237  
Grigio



238  
Nero



282  
Bihara



231  
Devon



232  
Surrey



281  
Kanran



283  
Cammello  
cross



284  
Cammello  
points



285  
Nero cross



286  
Nero points

LEGNO MASSELLO - H 23 mm

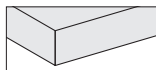

058  
Noce LIGHT  
canaletto  
"taglio sega"



057  
Abete "antico"  
grigio



066  
Olmo  
americano  
SW



067  
Frassino  
olivato  
termotrattato  
SW



102  
Rovere tinto  
affumicato  
SW

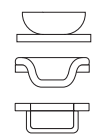

Base portlavabo con cassetto

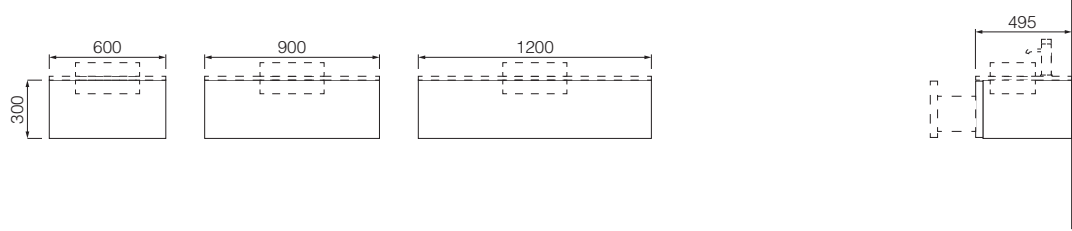

Base con cassetto

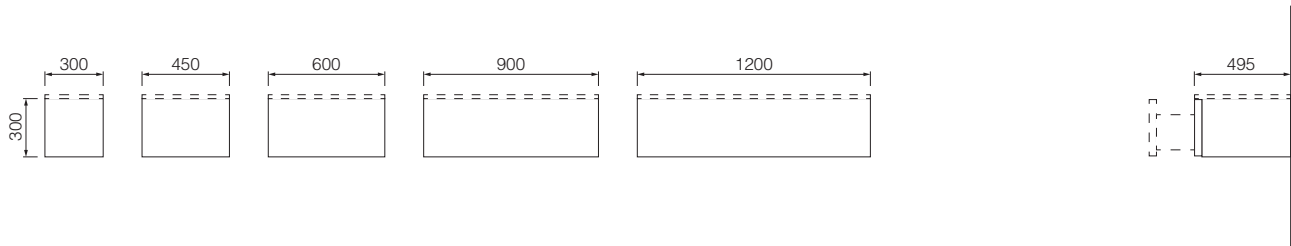

Base portlavabo con anta/e a battente

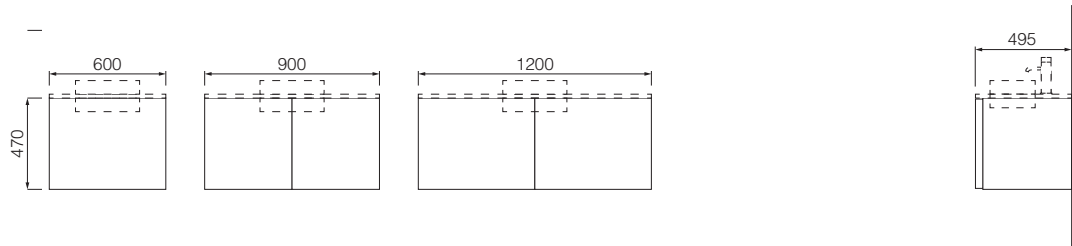

Base con anta a battente



Base portlavabo con 2 cassetti

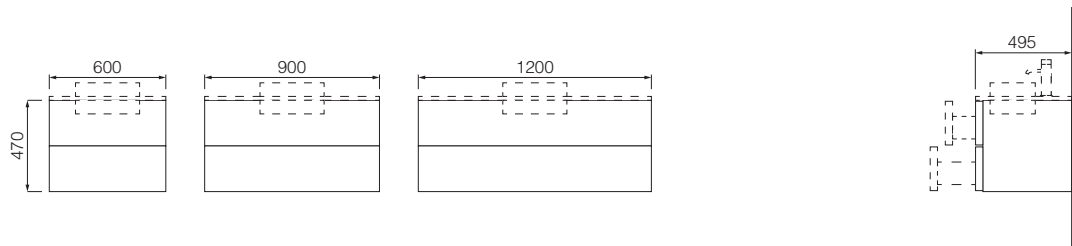

# Programma SIMPLE

DETTAGLI TECNICI - ABACO BASI

Base con 2 cassetti

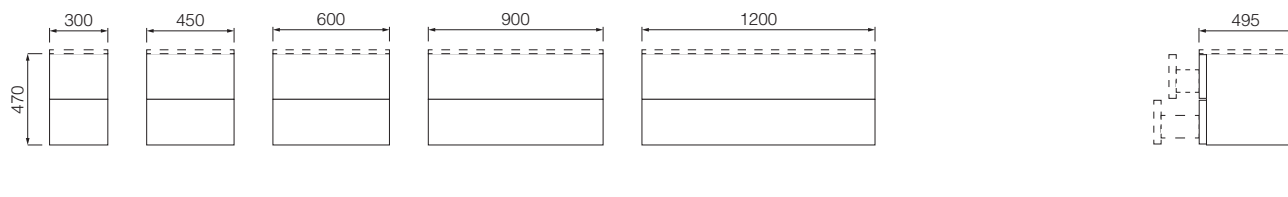

Base portalavabo con cassetto

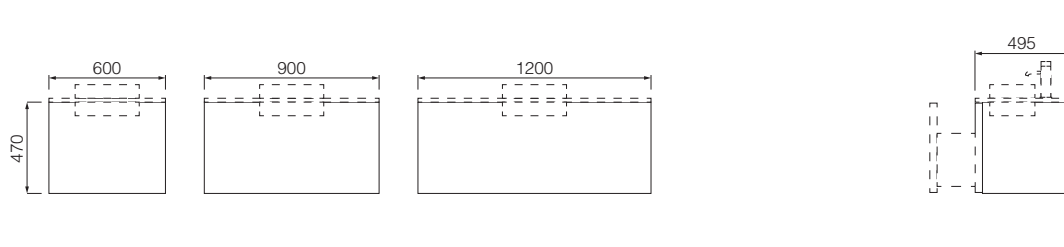

Base con cassetto + cassetto interno

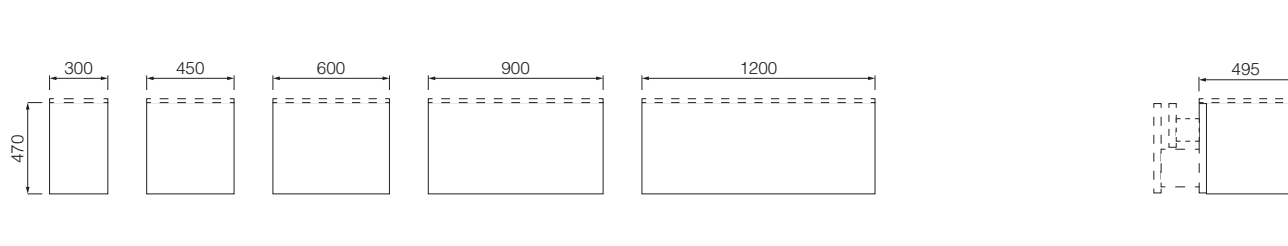

# Programma SIMPLE

DETTAGLI TECNICI

INTERNO BASI E COLONNE

## Basi portalavabo

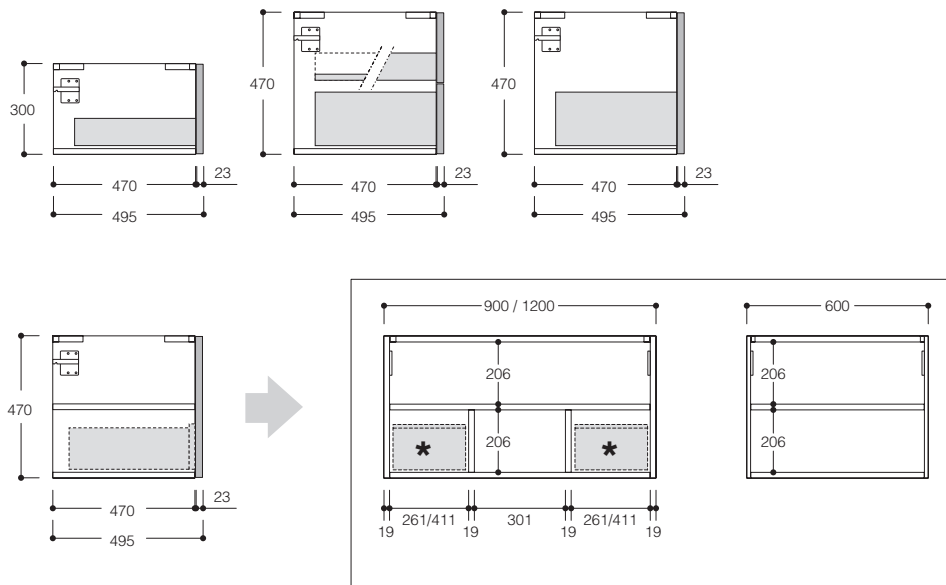

\* Cassetto opzionale

## Basi e colonne

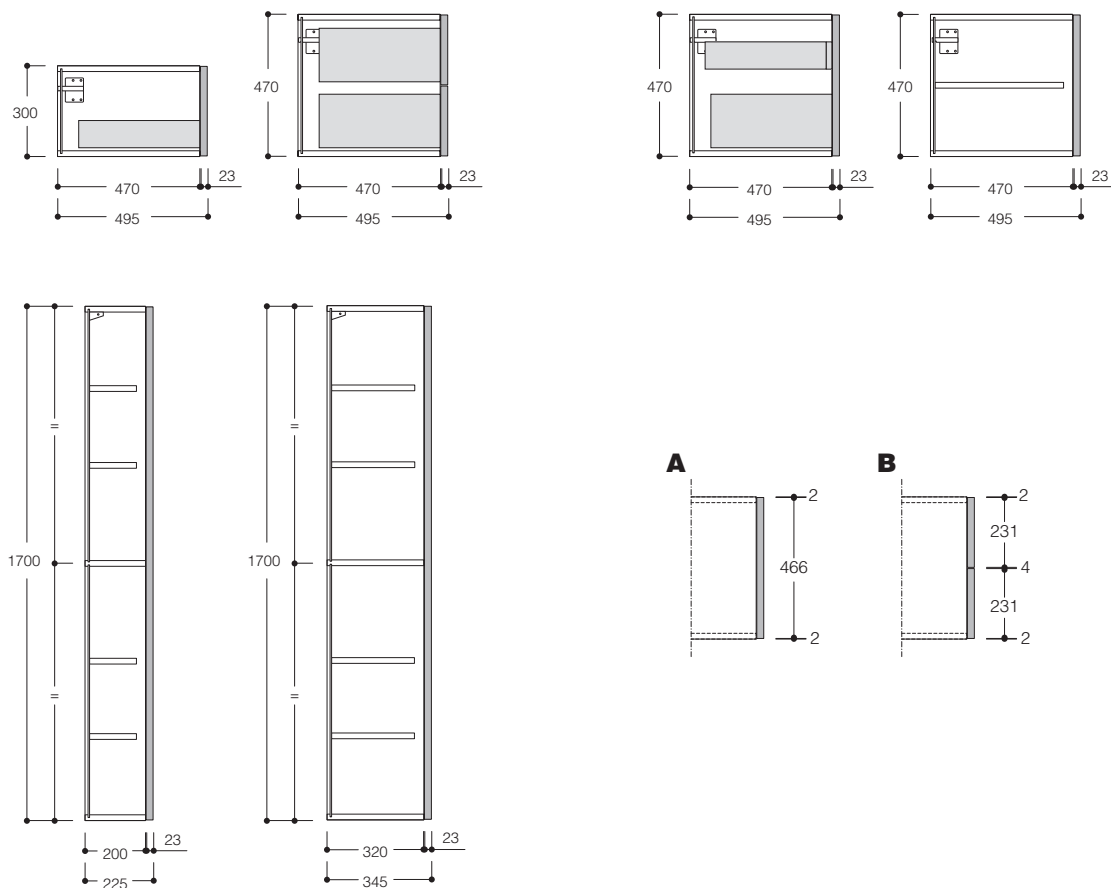

A - Dettaglio frontale unico H 470 mm  
B - Dettaglio frontale doppio H 470 mm



**Programma SIMPLE**  
 DETTAGLI TECNICI - POSIZIONAMENTO SCARICO ACQUA

"a" = Quota di posizionamento scarico acqua

A = Scarico acqua

B = Acqua fredda

C = Acqua calda

BASI H 300 - Lavabo SOPRAPIANO da appoggio

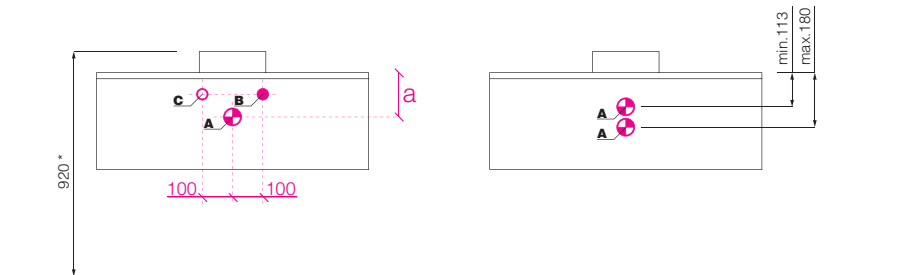
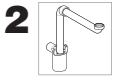
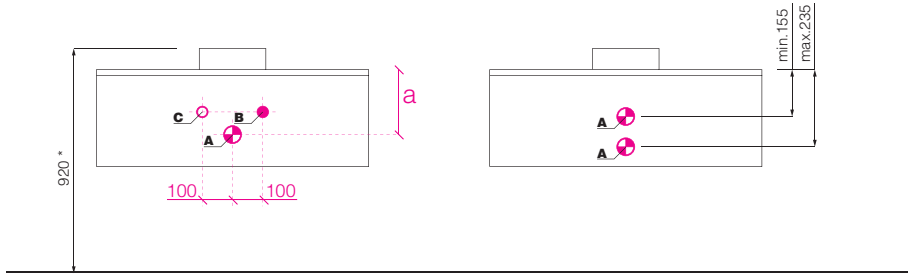
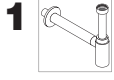

BASI H 300 mm - Lavabo SOTTOPIANO da incasso, FILOPIANO stampato e SOPRAPIANO da incasso.

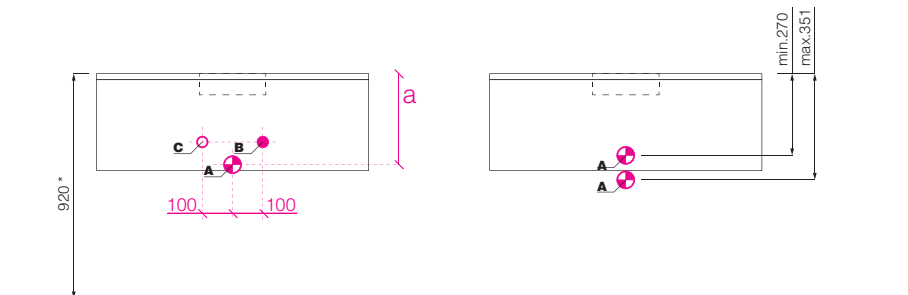
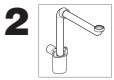
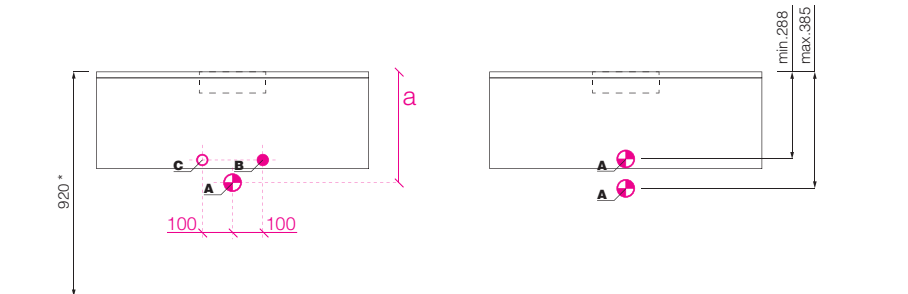
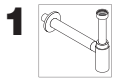

\* quota consigliata per utenti di statura media (170 ÷ 180 cm).

1 - Sifone cilindrico

2 - Sifone salvaspazio

# Programma SIMPLE

## DETTAGLI TECNICI - POSIZIONAMENTO SCARICO ACQUA

"a" = Quota di posizionamento scarico acqua

A = Scarico acqua

B = Acqua fredda

C = Acqua calda

### BASI H 470 mm - Lavabo SOPRAPIANO da appoggio

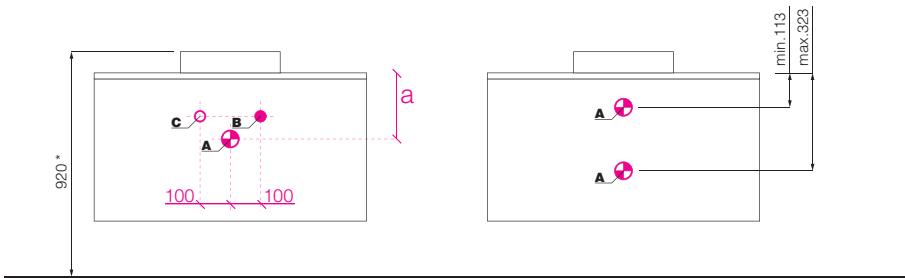
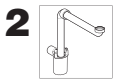
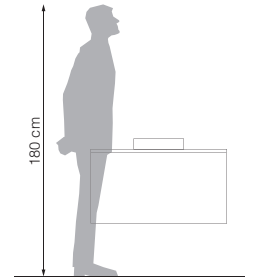
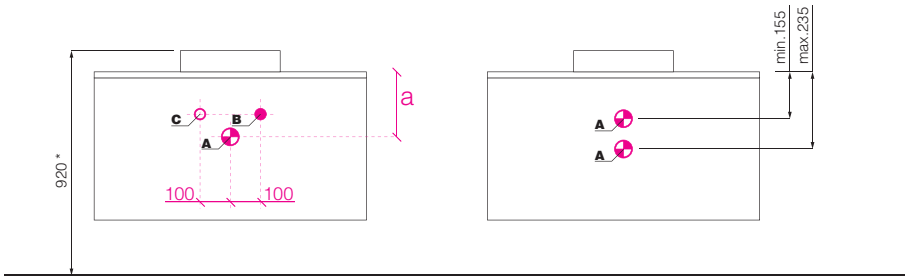
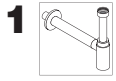

### BASI H 470 mm - Lavabo SOTTOPIANO da incasso, FILOPIANO stampato e SOPRAPIANO da incasso.

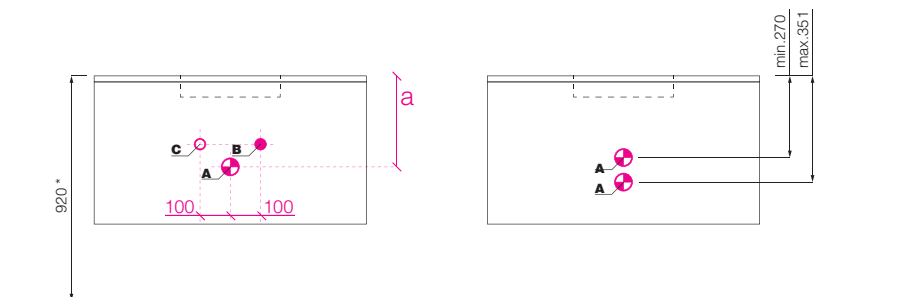
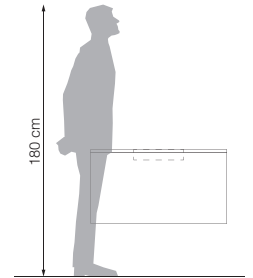
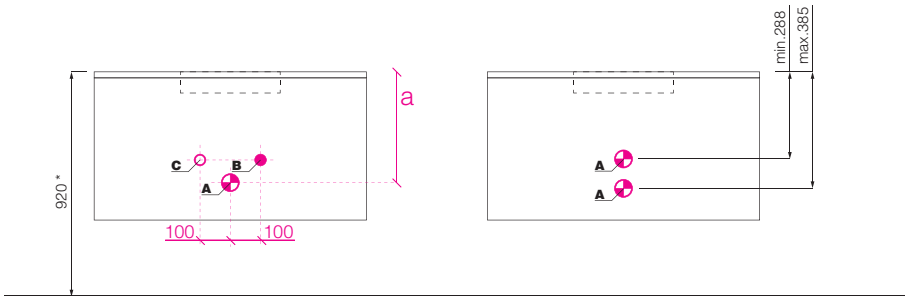
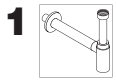

\* quota consigliata per utenti di statura media (170 ÷ 180 cm).

1 - Sifone cilindrico

2 - Sifone salvaspazio