

NeoWall

design Piero Lissoni

Elementi componibili di diverse dimensioni. Struttura in legno di pioppo e abete tamburato. Molleggi a nastri elastici intrecciati in caucciù rivestito. Imbottitura in poliuretano espanso a densità differenziata rivestito con materassino in piuma d'oca lavata e sterilizzata, racchiusa in settori separati oppure imbottitura in poliuretano espanso a densità differenziata e visco-soft "Xtra-pur" rivestito con falde di fibre acriliche. Piedini in PVC nero con regolabili oppure in acciaio inox satinato opaco.

Rivestimento in tessuto o pelle, entrambi interamente sfoderabili tramite velcro a strappo. L'assemblaggio tra i vari elementi avviene tramite speciali ganci.

Profondità di seduta 68-94cm.



Seduta 68x68

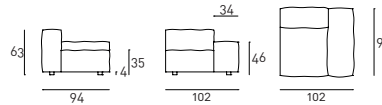
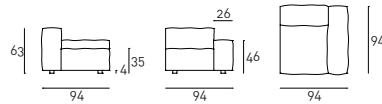
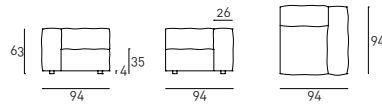
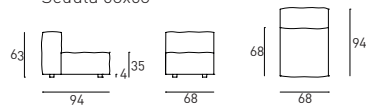

Seduta 94x68

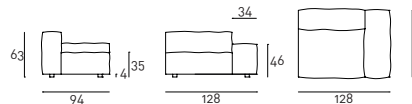
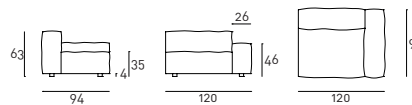
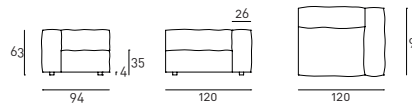
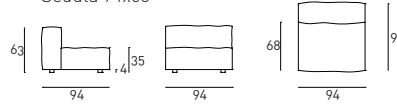

Seduta 127x68

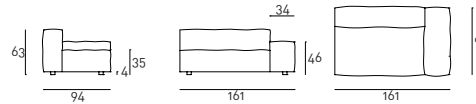
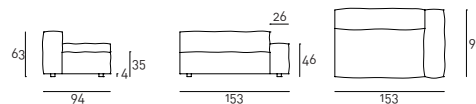
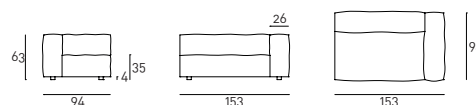
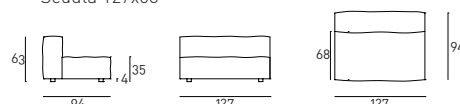

LIVING

D I V A N I

Seduta 94x94

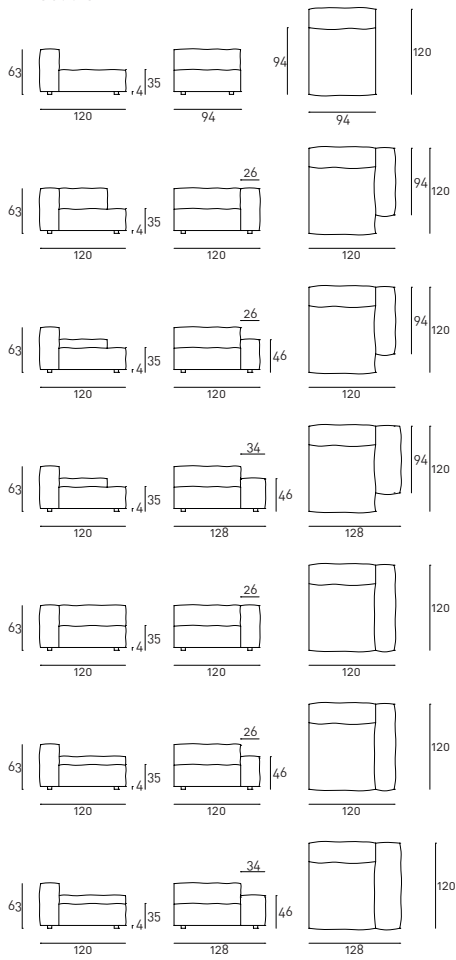

Seduta 127x94

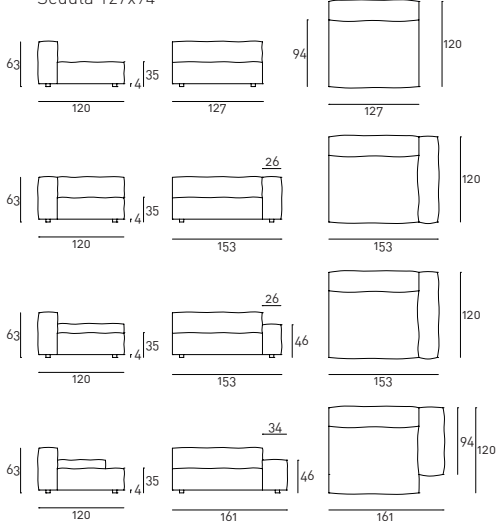

Seduta lunga

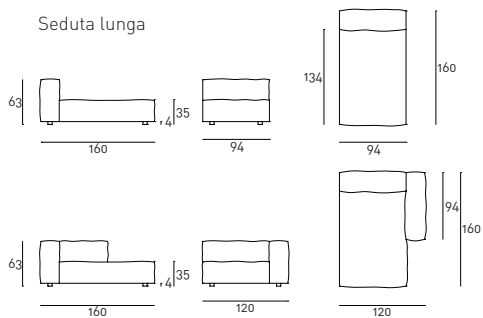

NeoWall
design Piero Lissoni

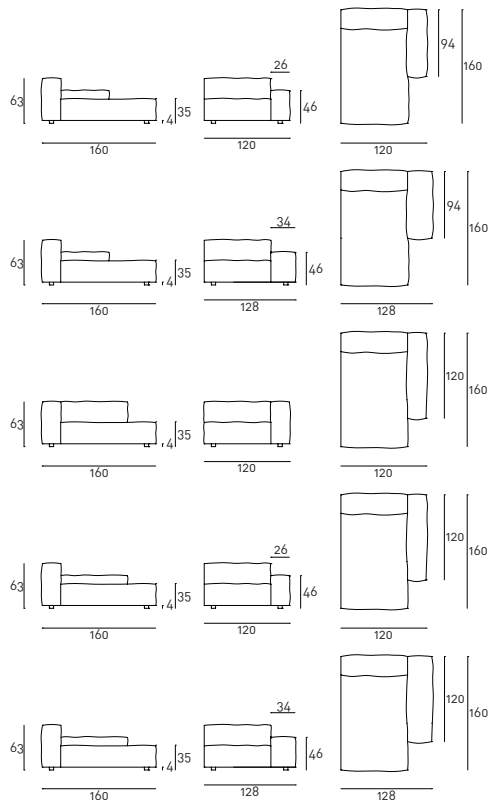

Elementi angolari

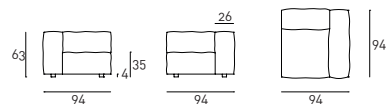

Pouf

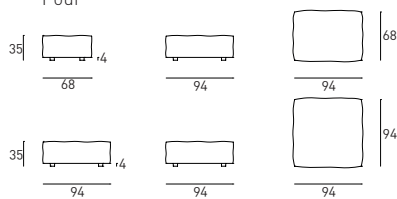

Piedini standard PVC

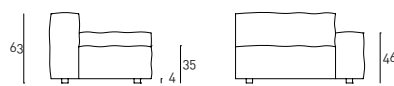

Piedini in acciaio inox AISI 304 satinato

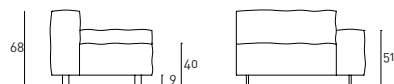

Cuscinetti

